



Destination
freedom.

Mobile Suites
2025







41FKRB - Tiramisu Cabinets with
SymphonyDinette Chairs and Pewter (Leather)

Room to live.

Established in 2003, DRV Luxury Suites has set the gold standard for those who dream of owning an unparalleled fifth wheel or luxury asset hauler. Our secret? It starts with you, our valued customer. We listen intently to your aspirations and desires, then pull out all the stops to craft the high-end fifth wheel of your dreams — one that stands for unwavering quality, residential-grade construction, and opulent features. We deliver without compromise, complete with customer service that exceeds expectations, and all-season livability for a truly fulfilling full-timing experience.

Choosing DRV means more than acquiring a luxury fifth wheel; it's about upgrading to a distinguished lifestyle on the move. With DRV, you gain not just a vehicle, but a steadfast companion that assures safety, comfort, and peace of mind, regardless of where you're headed. As you're now poised to indulge in the finest moments of life, opt for the luxury coach that embodies freedom with every mile traveled.





Mobile Suites

41 FKRB

Step into the extraordinary with the **DRV 41FKRB**, a front kitchen floorplan that redefines what it means to live luxuriously on the road. Indulge your inner chef in a gourmet kitchen designed to impress. Featuring a **residential 20 cu.ft. refrigerator**, a **four-burner stove**, and a **convection oven**, this space is ideal for creating memorable meals. The kitchen island, with its **overhead exhaust fan**, doubles as a functional centerpiece. Abundant cabinetry and **solid-surface countertops** ensure you have room to store and prepare all your favorite dishes. Cleanup is a breeze with the **large-basin sink** and integrated **dishwasher**.

The open concept transitions seamlessly from the kitchen to the living room, where thoughtful details create a haven for relaxation and entertainment. A **breakfast bar** overlooks the living area, offering a perfect perch for morning coffee. The spacious seating arrangement includes a sofa bed and **dual recliners**. Whether hosting guests or enjoying a quiet evening, the **entertainment center**—complete with a large-screen smart TV, electric fireplace, and Bluetooth soundbar—elevates every moment. Need a workspace? A built-in desk offers a functional solution with power outlets and cord management, or it can be replaced with additional seating or a dinette.

The **DRV Luxury Suites 41FKRB** is more than a fifth wheel—it's a statement of style and sophistication. Whether you're entertaining friends or relaxing in solitude, this model is your ultimate home away from home.







36RSSB3 - Italian White Cabinetry
with Nutmeg (Leather) Sofas

All The Luxuries of Home While You're On the Road.

The Mobile Suites is the foundation of DRV. It offers the comforts of home, including the conveniences of a residential kitchen, a master suite complete with a king sized bed and large bathroom, full washer and dryer connections in every floor plan, and the peace of mind that comes from knowing you've chosen the best construction available.

You expect the pinnacle of form, function, and design. By valuing and incorporating feedback from our customers, we have elevated our Mobile Suites to unprecedented heights.

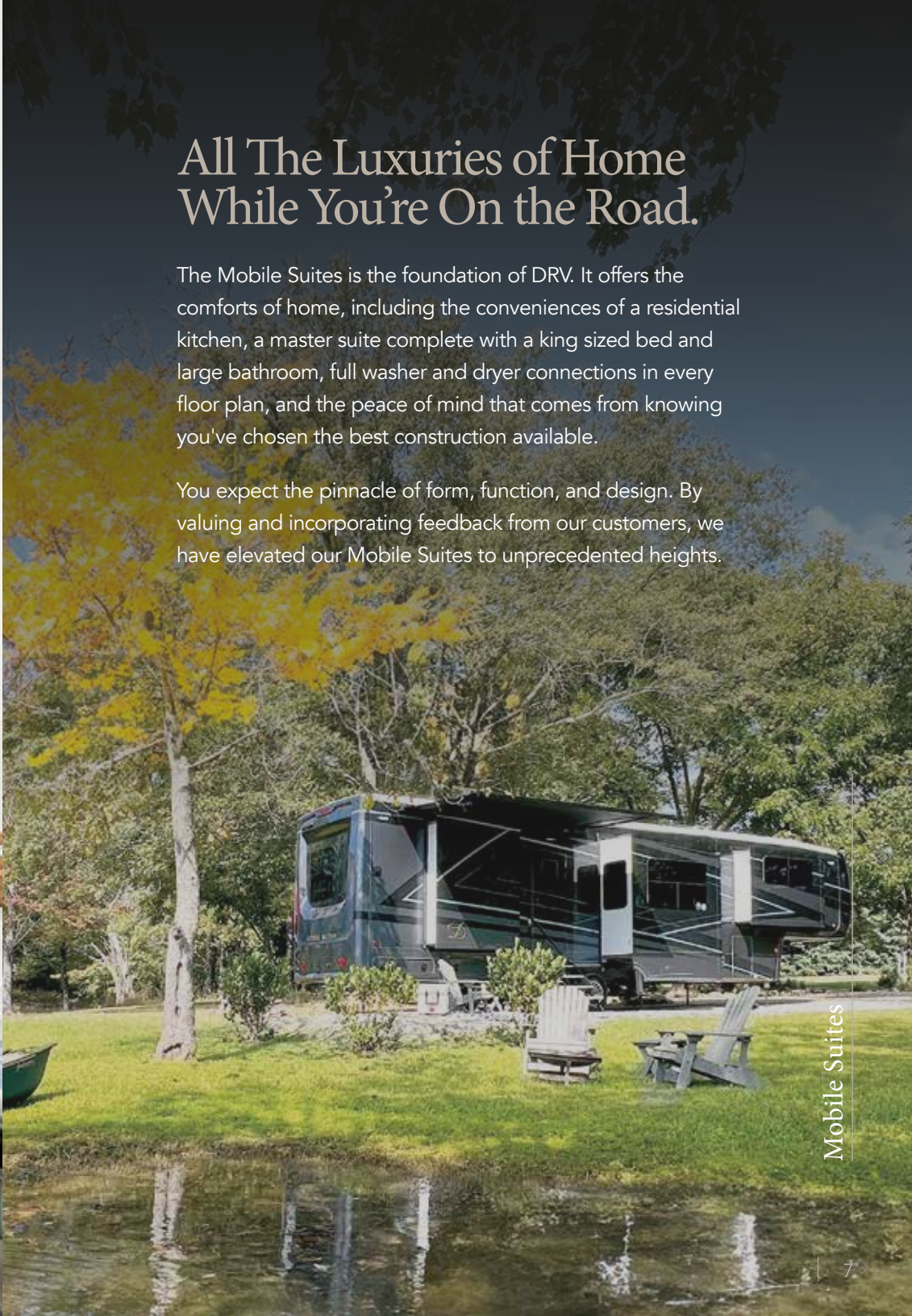

Mobile Suites





Mobile Suites

36DRSSB3

With DRV... you can have more.

Every model is equipped with a 20 cubic foot residential refrigerator, a residential-style gas oven, a stainless steel dishwasher, a convection microwave, soft close dovetail drawers and soft close doors. The interiors boast hand-laid rigid core plank flooring throughout the main floor and upper deck, complemented by a custom tile backsplash on solid surface countertops.

King beds are a standard feature in all floor plans, accommodating full under-bed storage which is ideal for those who live on the road as they navigate varying climates. Each master retreat includes nightstands, over-the-bed storage, and independently controlled reading lights on each side of the bed, enhancing both functionality and comfort.





Arctic Mist

Elite Package Full Body Paint (Option)



Capetown Veil

Elite Package Full Body Paint (Option)



Auburn Sands

Partial Body Paint (Standard)



Coastal Villa

Partial Body Paint (Standard)



Pacific Slate

Partial Body Paint (Standard)



Symphony Dinette Chairs

Mobile Suites

2025



Tiramisu Cabinets



Italian White Cabinets



Toffee Grove Cabinets



Aurora Magnolia Countertops

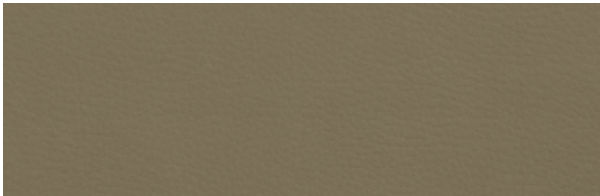

Nutmeg Sofas



Pewter Sofas



Sand Sofas



Gunmetal Flooring



Willow Flooring

The foundation of true freedom.

If there's one thing we've learned after all these years on the road, it's this: People choose DRV Luxury Suites because they're ready to *enjoy* life. They don't want to spend their time worrying about things like quality, construction and service. Which is why we put so much thought into them in the first place. Every DRV product is built to *last* — with our unique triple-stacked box tube frame, the thickest sidewalls in the industry, screwed and glued aluminum framing for unshakable stability, and dozens of no-excuses features that'll keep you safe, comfortable and worry-free, even when Mother Nature's at her worst.

Technology

State-of-the-art Level-Up™ leveling system and industrial hydraulic system. Level your coach with the push of a button.

Automotive style Kodiak® disc brakes. Limited lifetime warranty; smoother stopping; shorter stopping distance; low maintenance cost.

Heavy duty H-rated 17.5" tires and aluminum eight-bolt wheels. Heavier load capacity. Special tread pattern to dissipate heat. Tires are regroovable for miles and miles of safe use. Wheels are lightweight and will not rust.

SeeLevel tank monitoring system. Uses sonar to provide instant and accurate readings of all tanks.

ASA Voyager® 270 camera system. For better RV maneuvering and visibility on the road, the ASA Voyager® 270 camera system features a three-camera bird's eye view, turn signal triggers and audible blind spot alerts.

Structure

Custom engineered and tested 15" triple steel box tube chassis. Super strong foundation to build a lasting, high quality fifth wheel.

All-weather heavy duty aluminum floor system. The floor is screwed and bolted together and will not rot over time. We also refuse to use staples which eventually work up through the floor covering.

R-29 insulated frame floor system with three weather barriers. Warm floors for extended or full-time use; keep out condensation.

Slide floors will feature a **water-resistant composite subflooring**, which is lighter than traditional plywood and offers superior adhesion and durability against moisture. This lightweight material also contributes to improved fuel efficiency and allows for more cargo capacity.

At DRV Luxury Suites, we build each fifth wheel the same way we'd build our own home. And we appoint it with the finest luxury features available — lush homelike furnishings, fireplaces, large French door refrigerators, stainless steel appliances, top-of-the-line electronics and more. Then we back it up with the best quality control and customer service in the industry. Every single coach is tested before it ever leaves the factory. And, if you should someday have a problem, rest assured, we'll get it fixed. No matter where you are. Day or night.

Livability

Screwed and glued construction. Solid; 16" o.c. stud spacing.

3.25" aluminum framed walls with R-16 insulated rating. Exclusive foam core vapor barrier. Lightweight; lower heating and cooling cost; noise reduction; eliminates chance of condensation.

Radiused aluminum roof rafters on 16" centers. More space; more insulation; improved water run-off; maximum load capacity per square foot.

R-25 insulated roof system with plywood and rubber or fiberglass covering. Improved weather barrier; sound deadening; low maintenance; lower heating and cooling costs.

Soft touch interior ceiling. Sound proofing; easy to clean; extra insulation.

Refinements

Conveniently located wall switches control all lighting. Fingertip control of all task and decorative lighting.

Overhead batten strip LED room lighting on dimmer switches. Personal light control.

Designer cabinet doors and soft-close dove tail drawers and doors. Optimal storage; residential look; residential function.

NOTE: Some features shown are exclusive to specific makes and models. Please review the complete Standards and Options list for availability.

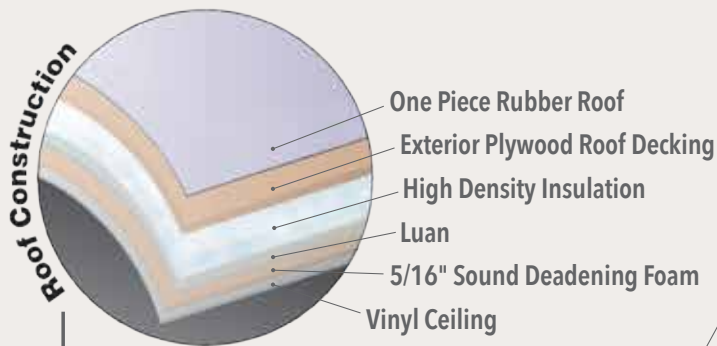

Residential Roof R25

- One Piece Rubber Roof
- Exterior Plywood Roof Decking
- High Density Insulation
- Luan
- 5/16" Sound Deadening Foam
- Vinyl Ceiling

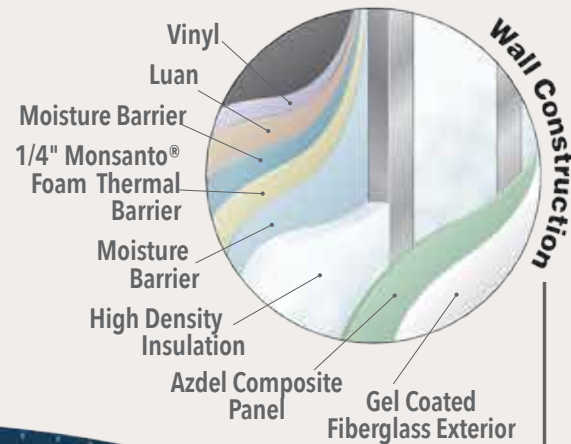

Residential Sidewall R16

- Vinyl
- Luan
- Moisture Barrier
- 1/4" Monsanto® Foam Thermal Barrier
- Moisture Barrier
- High Density Insulation
- Azdel Composite Panel
- Gel Coated Fiberglass Exterior



- Aluminum Roof Rafters 16" O.C.
- Vinyl
- Luan
- Moisture Barrier
- 1/4" Monsanto® Foam Thermal Barrier
- Moisture Barrier
- 1" x 2 1/2" Aluminum Studs

Hydraulic Jacks

- Composite Slideouts
- Hydraulic Stabilizer Jacks
- Slideout Hydraulics w/Individual Electronic Control
- Wider Tread
- High Density Insulation
- AZDEL Composite Panels
- Gel Coated Fiberglass Exterior

- Carpet/LVT Vinyl Flooring
- 5/8" T/G Exterior Grade Plywood
- 1" x 2 1/2" Aluminum Floor Joists
- High Density Insulation
- Vapor Barrier Underbelly
- 15" Steel Box Tube Chassis w/High Density Insulation
- Extruded Double-Layer Underbelly

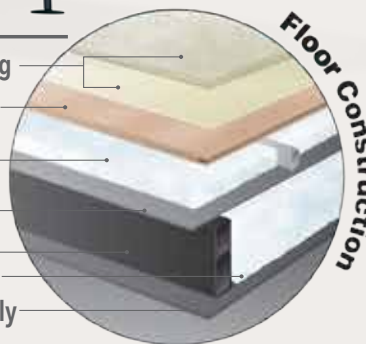

Residential Floor R29



All Season Thermal Pack with High Density Insulation

Standard on all Suites

Reliability

- High pressure hydraulic lines with metal fittings
- Individual push-button slide room controls
- Industrial stabilizer jacks located and wind tested to provide maximum stability
- Heavy gauge UL copper wiring
- Residential copper water manifold
- Reliable LED lights
- Convenient lights at all exterior service locations
- Gel coat fiberglass walls and exterior doors
- Plywood roof decking
- Extra sound proofing in floor, walls and roof
- Ultra quiet Trio Airflow A/C System
- Automotive disc brakes
- Furnace return air replaceable filter
- Oversized basement storage doors with gas lift cylinders
- Custom painted exterior
- Tough-skin, specially coated rock guard





Flooring

A Step Above in Style and Functionality

Say goodbye to outdated carpeted slide rooms. Our innovative flooring design eliminates carpet from all slideouts, creating a seamless, modern aesthetic that's easier to maintain. Additionally, we've removed heat registers from the floor in most floorplans, resulting in a clean, uninterrupted surface that enhances the elegance of your living space.

Sleek and Sophisticated Bathroom Design

Indulge in luxury with our new **Floating Vanity**, a striking design that brings a modern edge while maximizing floor space.



Enhanced Ambiance with Modern LED Lighting

Experience a brighter, more inviting atmosphere with our upgraded **Dimmable Batten Strip LED** Lighting, which replaces traditional puck-style lights. This sleek, contemporary dimmable lighting solution illuminates your space with style and efficiency, perfect for creating an elegant ambiance.

Appliances and Kitchen Details.

Premium Appliance Package

Our DRV Luxury Suites. Equipped with a premium Residential Appliance package—including a refrigerator, microwave, and range—your kitchen is ready for gourmet meals and effortless convenience.

Take your culinary experience to the next level with the **Kohler Residential Pull-Down Faucet** and **Kohler Brand Residential Workstation Sink**, designed for seamless functionality and modern elegance.

When it's time to unwind, immerse yourself in superior sound quality with the **Klipsch Audio Soundbar**, delivering unmatched clarity and depth for an elevated entertainment experience.

Dovetail Drawers offer enhanced durability and craftsmanship, combining both style and function for a refined kitchen experience.



Awnings

Sleek and Effortless Awning Design

Take your outdoor living to the next level with **Girard Legless Awnings**. These sleek, modern awnings extend and retract smoothly, offering shade and comfort without the bulk of traditional legs, allowing you to enjoy the outdoors with maximum convenience.

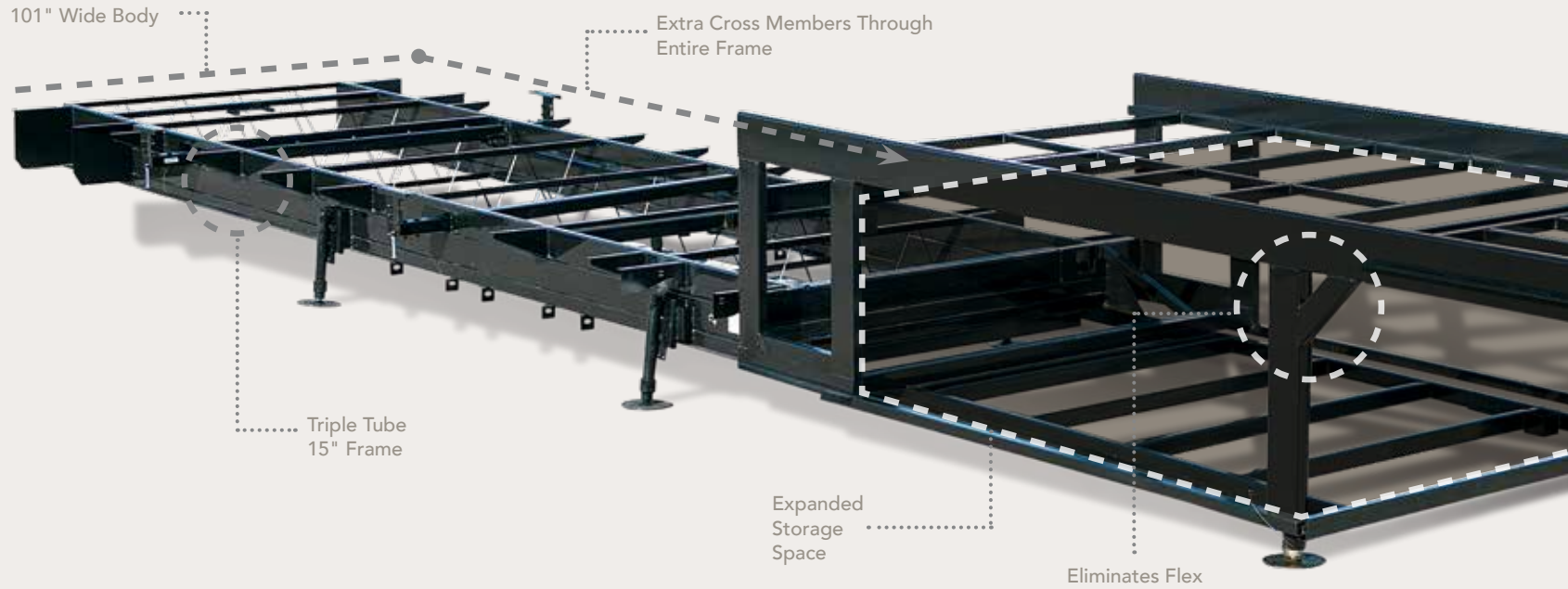

Stacked triple-tube steel frame for 15" of maximum strength; the largest foundation on any fifth wheel in the industry.



Pinless hydraulic jacks are mounted at a 5-degree angle for maximum stability.



Commercial hydraulic rack & pinion slide-outs. All gear boxes are located inside the frame for the ultimate weather protection.



Residentially hung sidewalls are carriage-bolted into the floor for solid construction and superior strength.



R-16 residential insulation completely surrounds all of our walls and slides. Best insulation in the industry and eco-friendly!



Solid Box Steel Frame

The foundation is the most important part of your home. It needs to be strong, reliable and able to last the test of time. DRV's custom-engineered 15" triple box tube frame measures 101" wide – the largest, most rigid fifth wheel frame in the industry. This design eliminates flex around the pin box and allows us to frame even the upper deck with steel to open up the storage compartment, providing you with space to fit all your personal belongings.

DRV 6-Jack Level-Up System

Designed by DRV, our 6-jack level-up system provides quick and easy leveling and the strength to stabilize the coach when set up.



3 1/4"



MORryde® I.S. Suspension eliminates the axle and leaf springs, allowing each tire to work independently. With 5 1/2" of travel per assembly, MORryde® I.S. will absorb road shock and protect your home for its lifetime.



Commercial E-Z Lube® hubs surrounded by 8 large 5/8" stud bolts and standard automotive disc brakes round out the safety features of every DRV unit.



Heavy-duty 17.5" tires provide increased load capacity while staying cool on long hauls. We use truck tires, not RV tires, to ensure better performance and peace of mind.

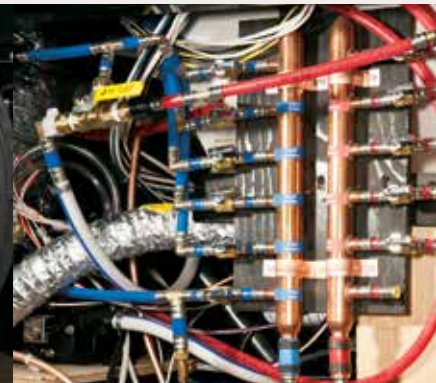

A copper water manifold comes standard, ensuring equal water pressure throughout your home. And each water line is clearly labeled and has its own shut-off valve, allowing you to isolate a single line without shutting off water to the rest of your home.



36 RSSB3

Length 38' 7" | Est. Dry Weight 16,600 Lbs.



41 FKRB

Length 43' 6" | Est. Dry 19,440



39 DBRS3

Length 41' 6" | Est. Dry 17,360



41 RKDB

Length 43' 1" | Est. Dry 18,220



40 KSSB4

Length 42' 3" | Est. Dry 18,380



43 MANHATTAN

Length 44' 11" | Est. Dry 19,985

ALL MODELS FEATURE *Note: All lengths are measured from the pin box to the rear cap. All dry weights are estimates depending on options. For GVWR please visit our website.*

- Fresh Tank - 100 gal.
- Gray Tank - 75 gal.
- Black Tank - 50 gal.
- SeeLevel Tank Monitor



44 HOUSTON

Length 46' 0" | Est. Dry 20,215



44 NASHVILLE

Length 46' 0" | Est. Dry 19,730



44 ORLANDO

Length 46' 0" | Est. Dry 20,860



Standards

Frame/Running Gear:

- 17 1/2" H-Rated Re-Groovable Tires
- Heavy Duty Grease Bolt Shackles w/Bronze Bushing
- Automotive Style Disc Brakes
- Heavy Duty 8,000 Lb. Rated Axles
- Commercial Grade EZ Lube Hubs
- 15" Triple Stacked Box Tube Frame
- 101" Wide Body
- Industrial Hydraulic System for Jacks & Lower Level Slides
- Electric Bedroom Slide
- Slide Outs w/Select Push Button Controls
- Pinless, Industrial Hydraulic Front Landing Jacks at 5° Outboard Angle

Construction: Floor

- 3" Thick Floor
- 14" O.C. Floor Aluminum Floor Joists
- Screwed & Glued Joist Construction
- 5/8" Tongue & Groove Plywood Flooring
- Residential Perimeter Heating
- Residential Rated R29 Formaldehyde Free Insulation

Construction: Walls/Slides

- 3 1/4" Thick Walls/Slides
- 16" O.C. Stud Spacing
- Screwed & Glued Aluminum Stud Construction
- 1/4" Monsanto® Fome-Cor Vapor Barrier (Eliminates Condensation)
- 1/4" Thick High Gloss Gelcoat Fiberglass
- Azdel OnBoard Composite Panels
- Residential Rated R16 Formaldehyde Free Insulation
- Composite Slide Floors

Construction: Roof

- 16" O.C. Rafter Spacing
- Residential Rated R25 Formaldehyde Free Insulation
- 1/2" Plywood Roof Overlayment
- Tuff-Flex Roof
- Soft-Touch Vinyl Ceiling, Including Interior Slide-Out Ceilings

Exterior:

- Straight Roof Line w/8' Tall Interior Slide Out Height
- High Gloss Gelcoat Fiberglass
- High Gloss Gelcoat Fiberglass Molded Caps
- Girarg Legless Awnings

- Custom Painted Exterior w/Clear Coat
- Frameless Tinted Safety Glass Windows
- LED Back-Up Lights
- Commercial LED Exterior Clearance Lights
- Front Cap Turn Signal
- LED Docking Lights
- 78" Entry Door
- Metal Slam Door Compartment Latches
- Extra Thick Compartment Doors w/Gas Struts
- Motion Sensor LED Lights in Basement
- Custom Enlarged Control Center w/LED Lighting
- Lend-a-Hand Exterior Grab Handle
- Power Awning w/Aluminum Weather Shield (Over Both Entry Doors)
- Water Pump Switch at Outside Hookup Center

Systems/Tanks:

- 50 Amp Service w/Detachable Cord
- 80 Amp 12 VDC Converter
- 100 Gal. Fresh Water Tank
- 75 Gal. Grey Water Tank w/Power Flush
- 50 Gal. Black Water Tank w/Power Flush
- SeeLevel Tank Monitoring System on All Tanks

- Residential Type 1/2" PEX Water Lines
- Exclusive Copper Water Manifold w/Individual Shut-Off Valves
- Whole House Water Filtration System
- Multi-Switch Water Bypass System
- Slide Out Propane Tray w/Dual 40 Lb. Tanks
- 12VDC Battery on Pull Out Tray
- On Demand Water Heater
- 40,000 BTU Furnace w/Custom Plenum
- Residential 5 Duct Heating System w/6" Ducting
- Forced Heat Ducting to Tanks/ Water System
- Fully Ducted A/C System w/Cold Air Return
- Wired Ducted Bedroom with Cold Air Return
- Double 15,000 BTU Low Profile A/C's (Triple 15,000 BTU Low Profile A/C's on MSEX)
- Solar Prep
- HD Roof Satellite Prep for Dual DVR Receivers
- HD Ground Satellite & Cable Prep
- HD TV Antenna

Interior: Luxury Living Room/ Dinette

- Klipsch Audio Soundbar
- Hand Laid Rigid Core Plank Flooring
- Solid Hardwood Cabinetry
- Interior Ceiling Fan (some models)
- Solid Hardwood Fascia Trim Around Slide Outs
- Solid Hardwood Cabinet Stiles (Pocket Drilled/Screwed)
- Concealed Soft-Close Cabinet Door Hinges
- Soft-Close Full Extension Metal Drawer Guides
- Batten strip LED interior ceiling Lighting on Dimmer switches
- Utility Closet w/Coat Storage & Centralized Control Station
- Custom Hardwood Dinette Buffet w/Solid Surface Top (Some Models)
- Dinette Table w/Hidden Leaf Extension (Some Models) (2) Hardwood Dinette Chairs w/Fabric Accent (Some Models)
- HD Wiring Throughout
- No Carpet in Slide Outs
- No In-Floor Vents (Some Models)
- Dimmable Ceiling Strip LED Lighting

Options

Interior: Gourmet Kitchen

- Dove Tail Drawers
- Residential Appliance Package
- Residential Style Stainless Steel Range
- 20 Cu. Ft. Residential Stainless Steel French Door Refrigerator
- Residential Pantry with Concealed Dove Tail Drawers
- Pull-Out 13 Gal. Garbage Can
- Stainless Steel Convection/Microwave
- Kohler Residential Pull-Down Faucet
- Kohler Brand Residential Workstation Sink
- Pullout Undersink Storage Caddy
- High Polished Solid Surface Countertops
- Lighted Pantries & Kitchen/Bathroom Toe Kicks

Interior: Master Bath/Hallway

- Hardwood Steps with Woven Insert
- Hand Laid Rigid Core Flooring
- Washer/Dryer Prep
- Heat & A/C Ducting in Bathroom
- Maxxair® Fan in Bathroom
- One Piece Fiberglass Shower
- Sky-Light Over Shower w/LED Pot Light
- Macerator Toilet (Some Models)

Interior: Master Bedroom

- Custom Walk-in Front Closet w/Built in Dresser (Most Models)
- Custom Hardwood Wardrobe Doors
- King Bed Suite 72" x 80" w/Innerspring Mattress
- Full Storage Under Bed Base
- 32" TV
- Dimmable Over the Bed Reading Lights on Separate Switches
- Vanity Slide

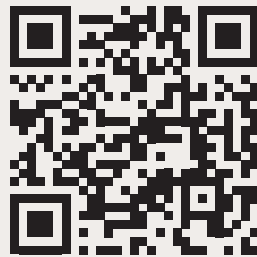

SCAN TO WATCH
THE MOBILE SUITES
BRAND VIDEO

Cabinetry (Standards):

- Tiramisu
- Italian White
- Toffee Grove

Dinette Décor (Standards):

- Symphony

Sofa Décor (Standards):

- Nutmeg
- Pewter
- Sand

Flooring (Standards):

- Gunmetal Flooring
- Willow Flooring

Counters (Standards):

- Aurora Magnolia (Solid Surface)

Entertainment:

- 32" LED HDTV Outdoor Entertainment
- Winegard® Trav'ler HD Auto Satellite
- Winegard 360 Plus

Bedroom:

- Built in Front Wardrobe Safe w/Keyless Entry
- Queen Bed Suite

Dinette:

- Toffee Grove Folding Chair
- Toffee Grove Dinette
- Solid Surface Bartop w/Storage

Systems/Vents/Fans:

- 15,000 BTU Ducted Lo/Pro AC – Bedroom
- Heat Pump
- Power Ventilator w/Switch Control – Bedroom
- Splendide® Front Load 2 Piece
- Splendide® XC 2,100 Combo
- Generator Prep
- Onan® 5,500 Marquis Gold Generator w/Prep
- 3,000 Watt Inverter w/Four 6V Batteries
- Surge Protector w/Voltage Protection & Remote Display
- Heat Pads on All Tanks w/Elbow Heater on Drain Pipe

Construction/ Running Gear:

- Power Cord Reel
- HBA Brake Cam (To be Ordered Special for Customers w/GM Trucks)
- MORryde® Step Above

Exterior/Awnings:

- Slide Toppers
- Power Dinette Slide Patio Awning w/Weathershield
- Slide Out Storage Tray (36"x90")
- Voyager 270 Camera System
- RVIA
- CSA

Partial Body Paint (Standards):

- Auburn Sands
- Coastal Villa
- Pacific Slate

Elite Package:

- One Piece Fiberglass Roof
- Custom Molded One Piece Fiberglass Fender Skirts
- Custom Full Body Paint Scheme w/Window Silks and Striping on Slide End Walls
- High Polished Quartz Countertops
- Power MCD Roller Shades
- ASA In-Command System
- Lit Hardwood Valances
- Arctic Mist Exterior Full Body Paint
- Capetown Veil Exterior

This brochure is based upon the latest product information available at the time of printing. DRV reserves the right to make changes at any time to prices, colors, materials, equipment, specifications and models, and to discontinue models without notice or obligation. Color representations are as close as photographic/print reproduction will allow. All specifications are approximate and dimensions nominal. Text and/or photos may represent equipment or décor items which may not be included as a standard item in your model of choice.

WELCOME TO MyDRV



MyDRV is a mobile app that allows customers to manage their RV, monitor warranty information, and track sales and past orders. You can also access a robust library of how-to content, checklists, and other valuable resources, right from your phone.

You can manage your RV online or by downloading the mobile app.

CREATE YOUR ACCOUNT

Download the mobile app or activate online.

*****@gmail.com

STEP 1
Create an account or sign in to get started.

*** ** 12345

10/14/2021

STEP 2
Verify your VIN number and purchase date.



STEP 3
Verify your email.

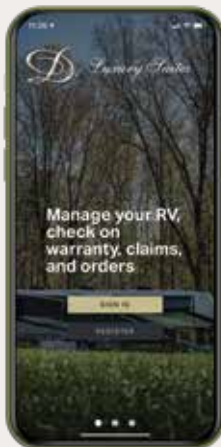



DRV Factory Tours

DRV Luxury Suites is open for factory tours, and we cannot wait to take you through the DRV build process and give you an in-depth look at the DRV Difference.

DRV factory tours are extremely important to our success and telling our story. Factory tours are a personal way to get to know our company and see many unique construction features we offer standard in all our products. We take pride in our quality and our construction and will spend as much time as we needed to make sure we answer all your questions. Factory tours are held **Monday, Wednesday, and Friday at 10 a.m. EST**, so please call ahead to schedule your tour.

Freedom is calling.

Mobile Suites

2025

Peace of mind from coast to coast.

Relax. Your new DRV fifth wheel is backed by the best customer service on the road. Whether you need a mobile tech, warranty work or just a little help figuring out your electronics, we'll make it right. Anywhere in America.

That's true freedom.

[DRVSuites.com](https://www.DRVSuites.com)

Destination freedom.



www.suitesowners.com | Be sure to join our outstanding DRV owner's club!

0160 W 750 N | PO Box 235 | Howe, IN 46746
Factory tours by appointment. Please call 260-562-1075 for specifics.

